

g u i d e

Spectrum™ Organ



u s e r ' s

SPECTRUM ORGAN
PEAVEY
MADE IN U.S.A.

DIGITAL PHASE MODULATION SYNTHESIZER

VOLUME

XPOS FINE R/CLICK VIBRATO
DRIV SPKR ROTARY REVERB
MODE CHAN



PEAVEY®



Intended to alert the user to the presence of uninsulated "dangerous voltage" within the product's enclosure that may be of sufficient magnitude to constitute a risk of electric shock to persons.



Intended to alert the user of the presence of important operating and maintenance (servicing) instructions in the literature accompanying the product.

CAUTION: Risk of electrical shock – DO NOT OPEN!

CAUTION: To reduce the risk of electric shock, do not remove cover. No user serviceable parts inside. Refer servicing to qualified service personnel.

WARNING: To prevent electrical shock or fire hazard, do not expose this appliance to rain or moisture. Before using this appliance, read the operating guide for further warnings.

Contents

QUICK START	4
INTRODUCTION	5
FEATURES	5
FRONT AND REAR PANELS OVERVIEW	6
On the Front	6
On the Rear	7
BASIC DESCRIPTION	8
SETUP	8
Basic Connection	9
Advanced Connection	10
Preset Control	11
Selecting the MIDI Mode	11
Autoflow	11
Setting the Bend Range	11
FX Selection	11
BASIC USE WITH THE PC 1600	12
ADVANCED USE WITH THE PC 1600	13
PATCH EDITING DESCRIPTIONS	13
Organ Prg Hdr	13
Organ Envelope	14
Organ Layer 1-4	16
Organ Rotary	17
Organ Drv/Spkr	18
Organ Vib/Rev	19
WAVEFORM REFERENCE LIST	20
APPENDIX A EFFECTS/VOICE ARCHITECTURES	21
APPENDIX B MIDI IMPLEMENTATION	22
APPENDIX C SYSEX AND CONTROLLER DATA	23
Spectrum Organ System Exclusive Implementation	23
Spectrum Organ System Exclusive Command Format	23
Universal SysEx Messages	27
Controller Data	28
APPENDIX D HISTORY OF THE B3	29

Quick Start

Hey, we know not everyone likes to read manuals or even needs to read manuals, that's why we are providing this quick start section. We want to make using your new Peavey equipment an easy, enjoyable, experience (after all, our products are for your enjoyment, so thanks for choosing Peavey).

▼ To get started quickly

1. Well, the first thing you need to do (after opening the box and removing the Spectrum Organ), is to connect the Spectrum Organ to your system configuration. Here are some things to check first:
 - Make sure your amplification system is turned off.
 - Turn the Spectrum Organ's Volume knob fully counterclockwise (effectively turning it off).
 - Plug the MIDI Out from your keyboard to the MIDI In on the Spectrum Organ.
 - Connect the mono/right audio output of the Spectrum Organ to the input of your keyboard amplifier. (If possible use a stereo connection; you won't be disappointed. Connect the left and right audio outputs to your amplification system with mono cables or use a stereo cable connected to the stereo/left audio output.)
 - Connect the power jack of the Spectrum Organ to an electrical outlet using the 16-16.5 volt AC 1000 mA adapter provided.
 - Turn on your amplifier.
 - See the diagram below.

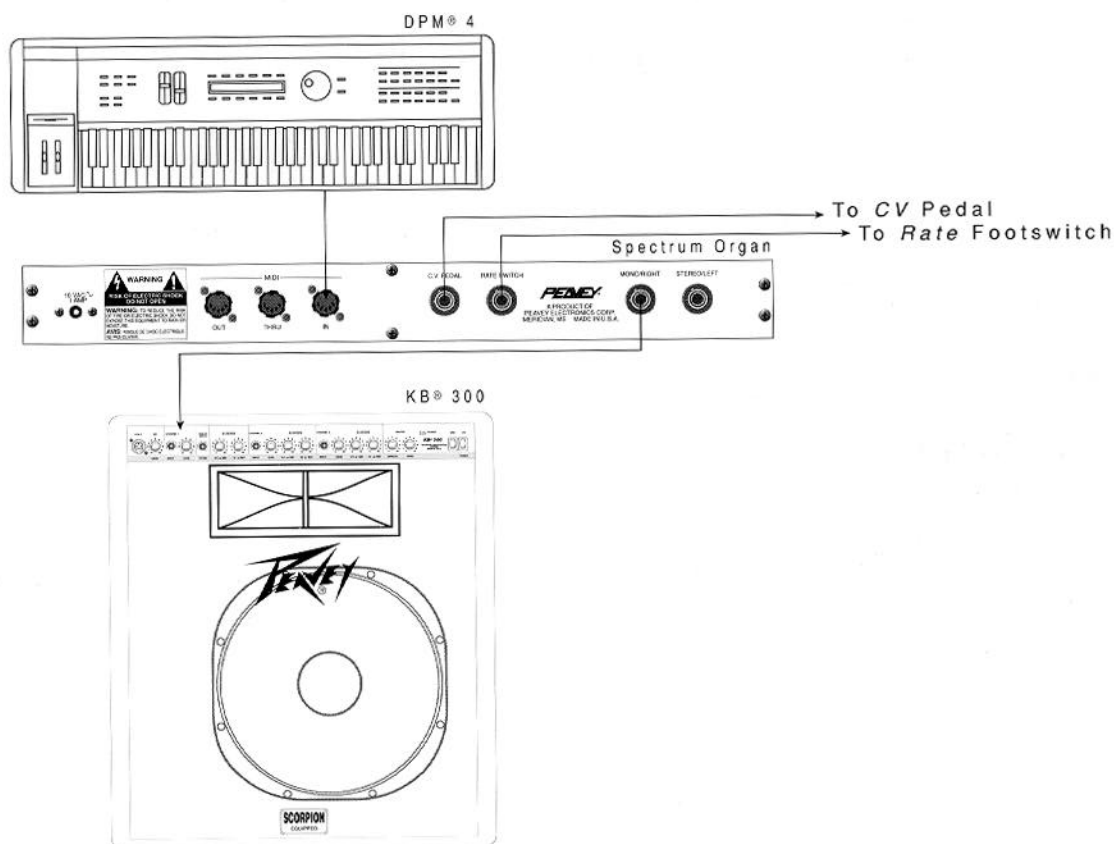

2. It is now necessary to properly set up your Spectrum Organ to send and receive MIDI information. To do this:

Setting the MIDI Mode

- ⌘ Press and hold the pair of buttons labeled **Mode**; while holding these buttons, press the ▲ and ▼ buttons until the display shows **Pol**. This puts you into poly mode. This mode allows you to send and receive MIDI data on one channel only.

Setting the MIDI Channel

- ⌘ Press and hold the pair of buttons labeled **Channel**; while holding these buttons, press the ▲ and ▼ buttons until the MIDI channel matches the MIDI transmit channel of your keyboard. If in doubt, try channel 1.

3. Okay. Now it's time to play.

- ⌘ Start playing your keyboard; as you play, turn the Spectrum Organ's **Volume** knob clockwise until you reach the desired volume.
- ⌘ The Spectrum Organ's display will show the current patch number. To select a different patch, use the ▲ and ▼ buttons.

4. That's it! Congratulations on a job well done.

INTRODUCTION

Congratulations and thank you for purchasing the Spectrum™ Organ and supporting products made in the U.S.A. The Spectrum Organ was designed to provide unparalleled organ waves for an affordable price. The Spectrum Organ features some of the finest B3, VOX and Farfisa (among other) samples available. We're sure that once you hear the Spectrum Organ you will be very pleased with your choice of organ voice modules.

FEATURES

- Classic organ waves from: B3, Korg CX3, VOX, Farfisa and classic synths
- 128 presets
- Real-time control of voice parameters through MIDI Controllers and SysEx
- 32-voice polyphony
- 1 megabyte of 16-bit waves
- Multi mode
- CV input for volume
- Footswitch jack for rotary speeds
- Stereo or mono outputs
- Special Effects such as reverb, speaker simulation, overdrive, vibrato, chorus, release click, and rotating speaker
- Simulated drawbar control with PC™ 1600

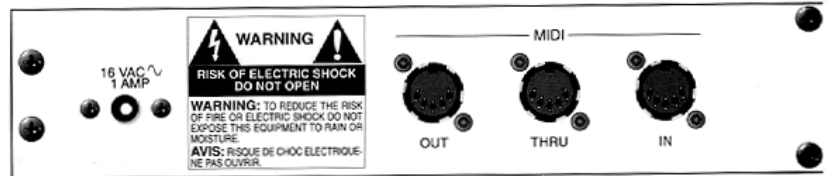
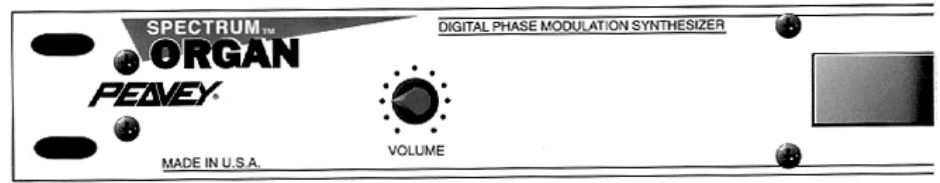

FRONT AND REAR PANELS OVERVIEW

On the Front

1. Volume

Controls the overall volume of the Spectrum Organ.

2. (▲) and (▼) Buttons

The ▲ and ▼ (increment and decrement) buttons are used to change programs and to perform adjustments to the Spectrum Organ's parameter settings if a parameter button is held down.

3. XPOSE Button

The **Xpose** button is used to transpose the pitch. The Spectrum Organ may be transposed any number of semitones to ± 2 octaves.

4. Fine Button

The **Fine** button is used to perform adjustments to the master tuning in increments of 1 cent, to a maximum of ± 99 cents.

5. R/Click Button

This allows the user to turn the release click off on the B3 waves. It has no effect on the other waves. There are three modes available: **OFF**, turns the release click off on all B3 waves; **Prg**, uses the B3 presets programmed setting for the release click; **on**, turns the release click on for all B3 waves.

6. Vibrato Button

This allows the Spectrum Organ to simulate the different vibrato and chorus modes of the B3. V1-V3 are straight vibrato at different amounts. C1-C3 are vibrato and straight signals at different amounts.

7. Drive Button

Allows the Spectrum Organ to simulate different amounts of speaker distortion from "light" to "out of control."

8. SPKR (Speaker)

This simulates different types of speakers with a filter system. This is a finely tuned system so it can narrow in on specific ranges of boost or cut with resonance.

9. Rotary Button

This allows the Spectrum Organ to accurately reproduce the rotating speaker effect. It has both rotor and drum with separate acceleration and deceleration rates, just like a real "Leslie" speaker.

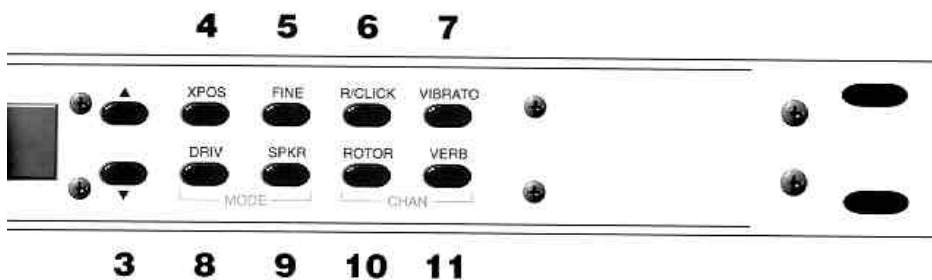

10. Reverb Button

This allows the Spectrum Organ to effectively reproduce different playing environments. (More or less reverb with variable damping.)

11. Mode (Double Button)

Pressing the **Drive** and **Spkr** buttons simultaneously allow you to set the MIDI mode.

12. Channel (Double Button)

Pressing the **Rotary** and **Reverb** buttons simultaneously allow you to set the MIDI receive/transmit channel.

On the Rear

1. Power Jack

Use only the 16-16.5 volt AC 1000 mA adapter provided. (Peavey part# 00710160.)

Caution: Use only the Peavey 16-16.5 volt power supply provided with this product. If the original power supply must be replaced, consult your Peavey dealer or the factory for the correct replacement. Failure to use the correct power supply could result in fire, shock hazard, extensive circuit damage, decreased performance, or non-operation.

2. MIDI Out Jack

This is a standard 5-pin DIN jack used for sending MIDI data from the Spectrum Organ to receiving unit(s).

3. MIDI Thru Jack

This is a standard 5-pin DIN jack used to echo MIDI data received at the MIDI In jack. This means that the receiving unit(s) will receive an exact copy of the MIDI data the Spectrum Organ received.

4. MIDI In Jack

This is a standard 5-pin DIN jack used to receive MIDI data from a sending unit.

5. CV In Jack

This 1/4" jack accepts standard CV pedals that can be used to control the volume of the Spectrum Organ. If a voltage pedal is used, it must be 0-10V.

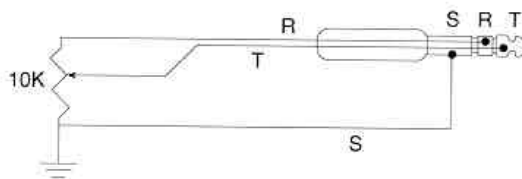

6. Rate

Uses a momentary switch to change the rotary speed from slow to fast. The polarity is sensed on power up, so a **NC** (normally closed) or **NO** (normally open) type can be used.

7. R/Mono

This is a standard 1/4" mono output jack. The output from this jack is the right channel if a plug is inserted into the L/Stereo jack and is the summed Left and Right channels if no plug is inserted into the L/Stereo jack.

8. L/Stereo

This is a standard 1/4" stereo output jack. The output from this jack is stereo when used with a stereo cable, with the Left channel on the tip, and the Right channel on the ring.

BASIC DESCRIPTION

The Spectrum Organ is a 32-oscillator sample playback synth with up to 4 oscillators per voice. These can be controlled like drawbars and/or percussion when used with a PC 1600. The waveforms consist of B3, CX3, Vox, Farfisa, synth and pipe organ sources. For greater variety, a set of fourteen attack waves have been added.

The user can select any of the effects on the front panel at any time. If they are left on "PRG," then the effect written into the program is active. If another number is selected, that becomes the global effect for all patches. You can also select off. This synth has been designed primarily as a drawbar (B3) type organ. It also contains several other organ types for a large variety of organ sounds.

These patches have been meticulously created to replicate these organ types as closely as possible.

If the user wishes to use a real "Leslie," he only has to turn off the effects, and he will have the "pure" wave at the output.

There are presets for virtually every kind of music in the Spectrum Organ. Many more can be made using the PC 1600. You can also use the PC 1600 for real-time control as drawbars or any SysEx command that the unit recognizes. (See the SysEx chart.)

The Spectrum Organ should fill any and all of your organ needs, establishing a new standard of quality, features and price.

SETUP

When you power up the Spectrum Organ for the first time you should see the program panel LED glow red. After you have hooked your MIDI keyboard to the module, set the receive channel by pushing and holding the pair of buttons labeled **Channel**; use the ▲ and ▼ buttons to select the MIDI channel. To set the Mode, push and hold the pair of buttons labeled **Mode**; use the ▲ and ▼ buttons to select the MIDI Mode. The available modes are **oni** (omni—all 16 channel receive), **Pol** (poly—1 channel receive), **2ch** (multi—2 channels), **3ch** (multi—3 channels), and **4ch** (multi—4 channels). 2ch, 3ch, and 4ch are multi mode selections. In these, the selected channel is your base channel and the others go up sequentially, wrapping back to 1 after 16.

The rear panel consists of your stereo/mono outputs, slow/fast rate pedal, CV input pedal, and of course MIDI in, out and thru.

To see if MIDI is being received, send data (notes, mod wheel, etc.) and there should be a little dot in the bottom right of the LED showing reception of any data.

Basic Connection

The following connection diagram represents what might be considered a “typical” keyboard setup. In this connection diagram we have included the DPM® 4 keyboard, Spectrum Organ and KB® 300 keyboard amplifier.

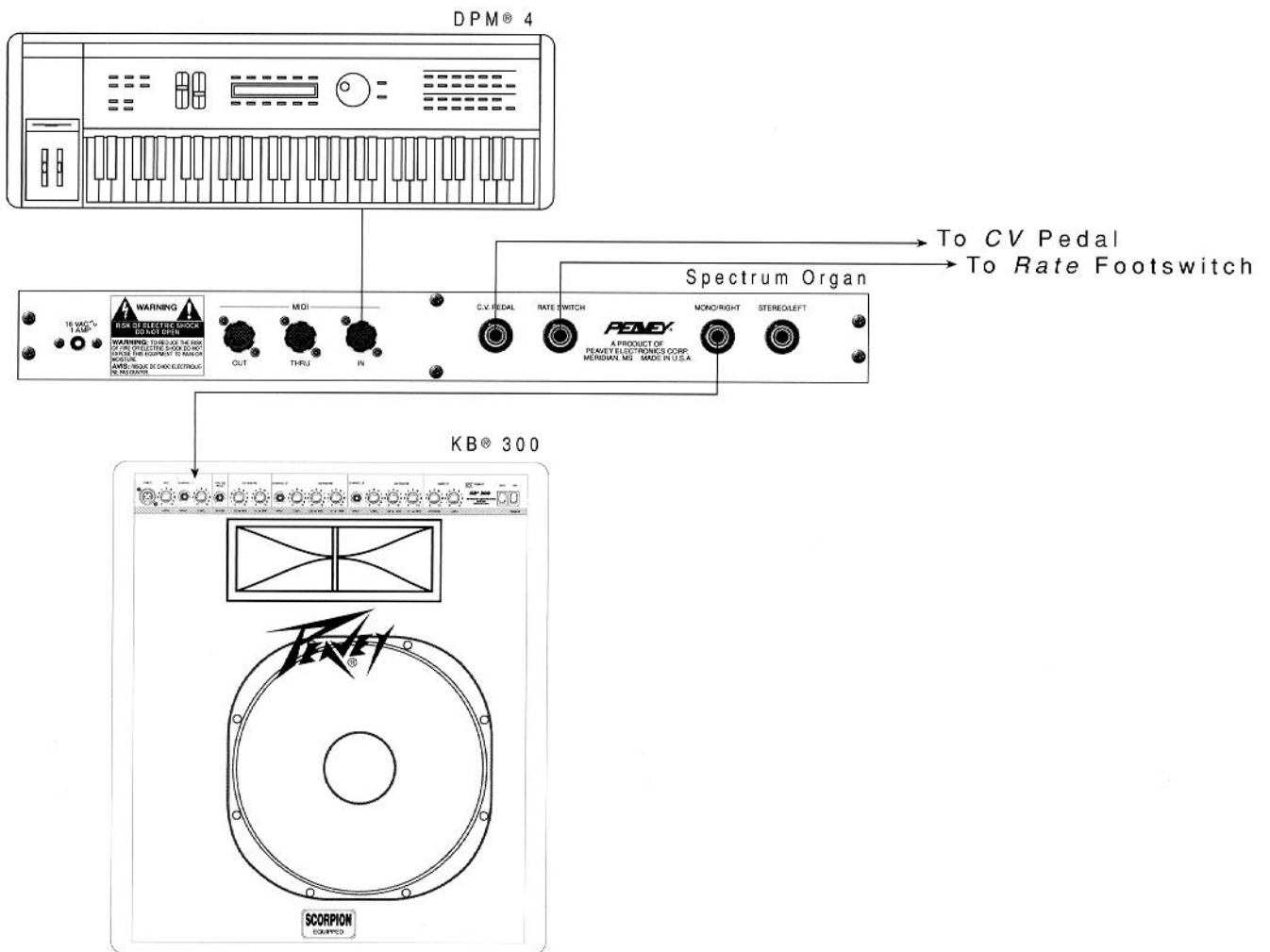

Advanced Connection

In this advanced connection diagram, we have taken a DPM 4 keyboard and connected it to a PC™ 1600 MIDI controller; we use this to provide real-time control of the drawbars (just like a real B3). To this we have added two Spectrum Organ modules, the second is used to automatically catch and play any overflowed notes. Next, we have taken this configuration and connected it to an amplification system that includes a mixer (this allows you to connect audio outputs from both the DPM 4 and the Spectrum Organ). The mixer is connected to a DPC™ 1000 digital amplifier and a pair of SP™ 2XT speaker enclosures.

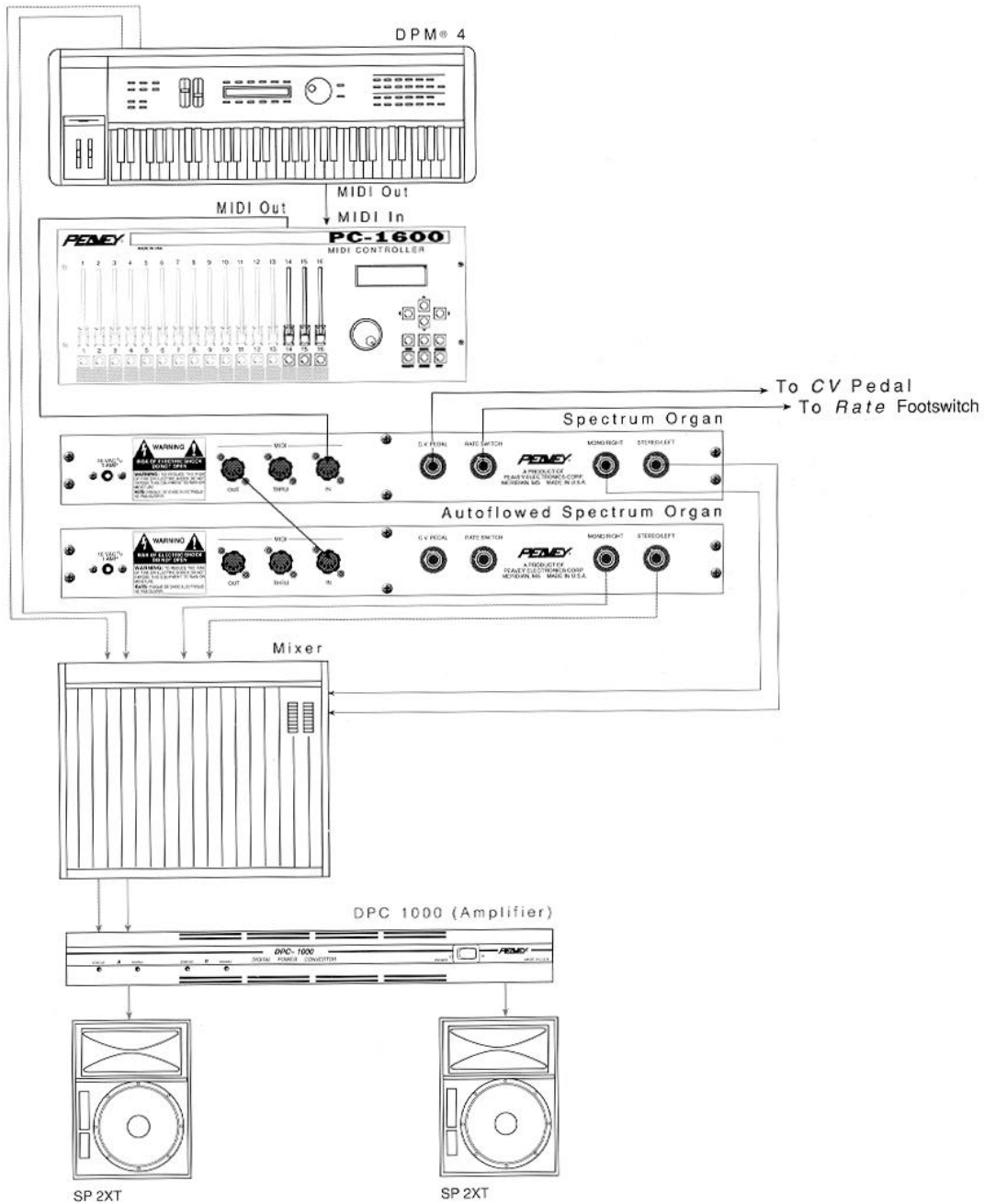

Preset Control

Use the ▲ and ▼ buttons to select a preset. When you power down, the last preset will return on power up. To increase the scrolling speed, press both the ▲ and ▼ buttons. For instance, to scroll up faster first press the ▲ button then press the ▼ button.

Selecting the MIDI Mode

The Spectrum Organ can be set to play up to four presets at once by using as many as four “parts.” For any effects set to “PRG,” those effects will be taken from the preset for part 1.

- oni** - sends on base channel, receives on all channels. All channels play part 1.
- Pol** - sends and receives on one channel only. Plays part 1.
- 2ch** - receives and sends on base channel and the next channel up. For example: If the base channel is channel 1, this will allow you to receive on channel 1 and channel 2. Plays parts 1 and 2.
- 3ch** - receives and sends on base channel and the next two channels up. For example: If the base channel is 1, this will allow you to receive on channels 1, 2 and 3. Plays parts 1, 2 and 3.
- 4ch** - receives and sends on base channel and the next three channels up. For example: If the base channel is 15, this allows you to receive on channels 15, 16, 1 and 2. Plays parts 1, 2, 3 and 4.

Note: The Spectrum Organ also utilizes Auto-Overflow which will play overflowed notes on the next unit.

Autoflow

Autoflow provides a simple and instant way to configure a second Spectrum Organ module for overflow purposes. When a MIDI cable is connected from the MID Out of the first unit to the MIDI In of the second, overflow status is automatically detected. Autoflow will cause the first unit in the chain to send out Note On and other events to the second unit when the maximum polyphony (32 voices) has been exceeded.

Autoflow mode is intended to work with additional Spectrum Organ modules which have the same configuration as the first in the chain—channel, MIDI mode, Multi patches, etc. Using Autoflow with any other MIDI tone module may not produce the expected results.

Setting the BEnd Range

To set the bend range, press and hold the Transpose and Fine buttons then use the ▼ and ▲ buttons to select the desired bend range.

FX Selection

FX refers to the following six buttons: **R/Click**, **Vibrato**, **Drive**, **Spkr**, **Rotary** and **Reverb**. Each patch uses one or more of these effects at a predetermined setting. Pressing any of these buttons allows you to alter the predetermined setting for that effect. Any changes you make to an effect are global.

Basic use with the PC 1600

The Spectrum Organ was designed to provide a seamless interface with the PC 1600 and provide true B3 type functions. To allow the PC 1600 to control the Spectrum Organ it is necessary to send the Organ Control patch from the Spectrum Organ to the PC 1600. This patch resides in the Spectrum Organ's ROMs.

Note: Your PC 1600 must have software version 1.1 or newer to use this feature.

▼ To download the Organ Control Patch

1. Connect the MIDI Out on the Spectrum Organ to the MIDI In on the PC 1600.
2. Select a patch number (0-49) on the Spectrum Organ to transmit to the PC 1600.

Note: The Organ Control Patch resides in the Spectrum Organ's ROM set and has no patch number associated with it. By selecting a patch number and then sending the Organ Control Patch you are, in essence, instructing the Spectrum Organ to send the Organ Control Patch to the PC 1600 and store it in the patch number selected. This allows you to place the Organ Control Patch in any PC 1600 patch you desire.

3. Press and hold the **Xpose** and **Fine** buttons, then press the **Rotary** button. The PC 1600 display should briefly show the following message:

Receiving PC 1600
 System exclusive msg

4. Now you will need to reconnect the MIDI cables to their original locations. (i.e., connect the MIDI Out on the PC 1600 to the MIDI In on the Spectrum Organ.)

The following is a table of the functions provided by the Organ Control patch that you just loaded into the PC 1600.

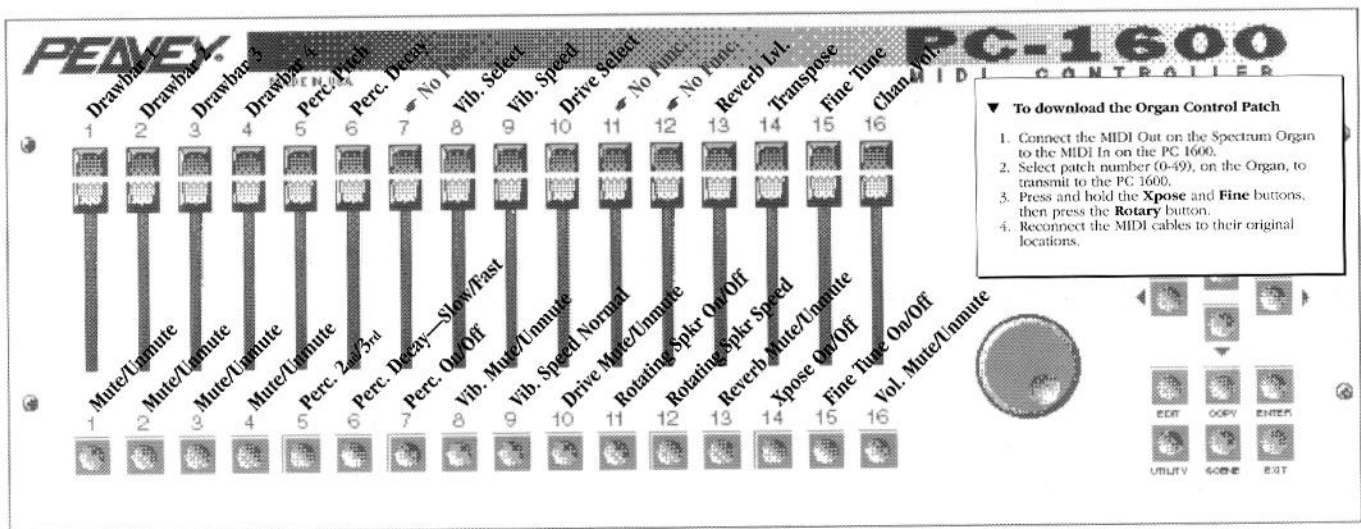

Note: To have a footswitch toggle the rotating speaker speed, set **Ftsw1** on the **UTIL** menu to Btn12.

Advanced use with the PC 1600

When using the Spectrum Organ with a PC 1600 it is possible to create your own patches. When you create a patch it is loaded into the edit buffer overwriting what is there. You can create a patch by editing an existing patch or by starting from scratch. It is important to note, however, that any patch you edit or create will be lost—by changing the patch number or turning the power off—so if you like what you have, save it. You can save your creations by dumping them to the Peavey MIDI Streamer™ or any other SysEx recorder.

The Spectrum Organ contains ten PC 1600 patches for use in creating your patches in its ROM. To begin editing/creating patches, you must first download these patches to the PC 1600.

▼ To download the Organ creation patches

1. Connect the MIDI Out on the Spectrum Organ to the MIDI In on the PC 1600.
2. Select a starting patch number (0-40) on the Spectrum Organ. This sets the starting destination patch number for the first patch sent; each successive patch will be loaded into the next higher patch number.

For example: Since there are ten patches to be downloaded, ten sequential locations are required; selecting patch number 20 as the starting patch number will load the patches into patch locations 20 through 29.

3. Press and hold the **Xpose** and **Fine** buttons, then press the **Reverb** button. The PC 1600 display should show the following message:

```
Receiving PC 1600  
System exclusive msg
```

If you receive the following message on the Spectrum Organ, you have selected a starting patch number on the Spectrum Organ that is higher than 40.

```
Err
```

4. Now you will need to reconnect the MIDI cables to their original locations. (i.e., connect the MIDI Out on the PC 1600 to the MIDI In on the Spectrum Organ.)

Note: If the other 40 patches are large, the 10 patches may not fit. Try trimming the 10 that are to be replaced first, and if they still don't all make it in, try trimming some of the other 40.

PATCH EDITING DESCRIPTIONS

Organ Prg Hdr

Fader 1—Patch Volume (0-99)

This sets the overall volume for the patch.

Fader 2—PercussDecay (0-99)

Sets the decay time for Layer 4 when selected as the percussion layer. It ranges from 0 (no decay) to 99 (max. decay).

Fader 3—ModWheelRemap (0-127)

This remaps the mod wheel to any MIDI controller supported above 64. See Appendix C for a complete listing.

Fader 4—ModWheelScale (0-127 & 128-255)

This sets the amount for the controller selected. This parameter has two modes: *mode 1* (0-127) allows you to set the maximum amount when the mod wheel is all the way up; *mode 2* (128-255) allows you to set the minimum amount when the mod wheel is all the way down.

For example: (Mode 1) Lets say that **ModWheelScale=120** and **ModWheelRemap=80** (layer 1 volume). This means that the volume has a range of 0 to 120. Setting the mod wheel all the way down will give you a value of 0 (no volume). Setting the mod wheel all the way up gives you a volume of 120, not quite the maximum volume possible (127) but very close. (Mode 2) Now lets say that the **ModWheelScale=235** and we are still controlling layer 1 volume. Setting the mod wheel all the way up gives you a value of 127, which is the maximum volume possible. Setting the mod wheel all the way down gives you a volume of 20 (255-235=20), so you have a small amount of volume on all the time. The larger the number, the larger the range. In this case it's (235-128=107).

Fader 5—PressureRemap (0-127)

This remaps the pressure to any MIDI controller supported above 64. See the chart on page 28 for a complete list of supported controllers.

Fader 6—PressureScale (0-128)

This sets the amount of aftertouch for the controller selected from 0 (min. amount) to 128 (max. amount).

Button 1—InitEditBuf

When pressed this initializes (erases) whatever is in the edit buffer to a sine wave patch with no effects.

Button 2—DumpEdit Buffer

When pressed this sends the patch in the edit buffer to any Sysex recorder, such as a Peavey MIDI Streamer.

Organ Envelope

Fader 1—Patch Volume (0-99)

This sets the overall volume for the patch.

Fader 2—PercussDecay (0-99)

Sets the decay time for Layer 4 when selected as the percussion layer. It ranges from 0 (no decay) to 99 (max. decay).

Fader 3—Amp 1 Level (0-99)

This sets the envelope parameter level from 0 (min. level) to 99 (max. level). See the chart below for a typical envelope.

Fader 4—Amp 1 Time (0-99)

This sets the envelope parameter time from 0 (min. level) to 99 (max. level). See the chart below for a typical envelope.

Fader 5—Amp 2 Level (0-99)

Same as Amp 1 Level.

Fader 6—Amp 2 Time (0-99)

Same as Amp 1 Time.

Fader 7—Amp 3 Level (0-99)

Same as Amp 1 Level.

Fader 8—Amp 3 Time (0-99)

Same as Amp 1 Time.

Fader 9—Amp 4 Level (0-99)

Same as Amp 1 Level.

Fader 10—Amp 4 Time (0-99)

Same as Amp 1 Time.

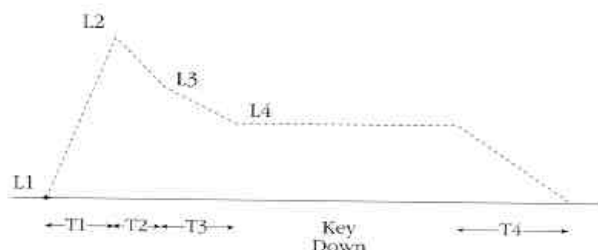

Fader 11—LevlModByVel (± 99)

Scales the envelope generator level according to velocity. When set to 0, velocity will not affect the envelope levels. Positive values increase the envelope values according to your dynamics up to the maximum pre-programmed levels. The higher the value, the lower the envelope levels go when you play softly. A setting of +99 gives the maximum dynamic range. Negative values decrease the levels according to your dynamics; the more negative the value, the more the envelope levels will tend to go toward 0 when you play harder. A setting of -99 gives the decreased dynamic range.

Fader 12—LevlModByKey (± 99)

This ties the envelope generator levels to keyboard note position. This is useful if you want a note's overall amplitude to depend on where you play it on the keyboard. The relationship between envelope levels is preserved; these changes scale the levels rather than force them to all jump to the same envelope. A setting of 0 means that the envelope level will not be affected by where you play on the keyboard. With positive values, the levels will increase as you play from left to right on the keyboard. With negative values, the levels will decrease as you play from left to right on the keyboard.

Fader 13—TimeModByVel (± 99)

This ties the Amp 1 Time envelope generator to velocity. An Amp 1 Time setting of 0 means that the envelope times will not be affected by velocity. If Amp 1 Time sets an attack time (i.e., Amp 1 Level has a lower value than Amp 2 Level), positive values increase the attack time as you play harder; negative values decrease the attack time as you play harder. The latter is useful for sounds (wind, voice, etc.) which have a sharper attack when played forcefully. If Amp 1 Time sets a decay (i.e., Amp 1 Level is higher than Amp 2 Level), positive values increase the decay time as you play harder; negative values decrease the release time.

Fader 14—TimeModByKey (± 99)

This ties the Amp 1 Time to keyboard note position. As you play higher up on the keyboard, positive values increase the attack time and negative values decrease the release time.

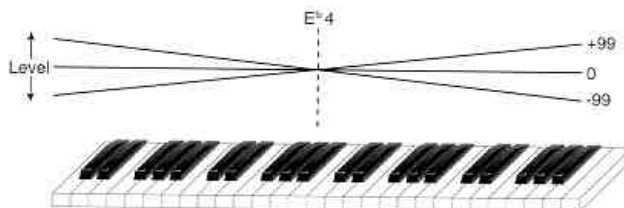

Organ Layer 1-4

Note: The Organ has four layers; each has the same parameters. We will show the definitions using Layer 1.

Fader 1—Layer Volume (0-127)

This sets the overall volume of the layer.

Fader 2—Layer Enable (0-31)

This determines what is on this layer. Use the following table when constructing your layer.

0	=	Layer Off
1	=	Layer On
Add 2	=	Percussion On (Authentic Mono)
Add 4	=	Modern Percussion (Poly)
Add 8	=	R/Click On
Add 16	=	Bias table On

So what does this mean exactly? How about a couple of examples.

Example 1: You want your layer to use percussion (mono) and a release click. If you take the numbers from the table above, you get 1, 2 and 8. Add these together ($1 + 2 + 8 = 11$); use this number as your Layer Enable setting. (In case you are wondering, we used 1 because that turns the layer on.)

Example 2: Suppose you only want a release click. Again, using the numbers above, we get 1 and 8. Added together, you come up with 9. Use this as your Layer Enable setting.

It is important to note that any number other than the sum of the numbers listed is invalid and will not make a sound. Also, if you don't enable the layer, you won't get a sound.

Fader 3—minMIDINote# (0-127)

This sets the lower end of the keyboard range for this layer.

Fader 4—maxMIDINote# (0-127)

This sets the upper end of the keyboard note range for this layer.

Fader 5—min Velocity (0-127)

This sets the lowest velocity amount that the *layer* will respond to.

Fader 6—max Velocity (0-127)

This is the maximum velocity amount that the *layer* will respond to.

Fader 7—OscWaveShape (0-67)

This selects the wave this layer uses. Select from any of the sixty-eight available waves. See the waveform reference on page 20 for a complete listing.

Fader 8—Coarse Tuning (± 24)

This allows you to tune the waves in semitone steps.

Fader 9—Fine Tuning (± 99)

This allows you to fine tune the waves in cents.

Fader 10—DrawbarTunin (0-9)

This tunes the layer to one of the drawbars on an organ. See the following chart.

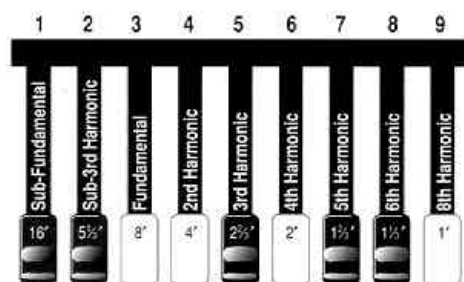

Generally, this feature is used with OscWaveShape #1 (single drawbar), tuning the wave to one of the nine found on a B3 and using foldback. A value of 0 plays at the fundamental frequency without foldback.

Fader 11—PitchModByKey (± 99)

This allows you to change the pitch of the keyboard from the normal 12 notes per octave down to one note for the entire keyboard.

Fader 12—LyrDelayTime (0-99)

Sets the amount of delay before the layer begins to sound. A setting of 0 produces no delay, while a setting of 99 produces the maximum delay. For example, you can create a four note arpeggio by setting a different delay time for each layer.

Organ Rotary

Fader 1—ROT Hi (0-127)

This sets the maximum rotor speed.

Fader 2—ROT Acc (0-127)

This sets the amount of time it takes for the rotor to go from low to high speed.

Fader 3—ROT Lo (0-127)

This sets the minimum rotor speed.

Fader 4—ROT Decel (0-127)

This sets the amount of time it takes for the rotor to go from high to low speed.

Fader 5—ROT Vol (0-127)

This sets the volume of the rotor.

Fader 6—ROT Am Dep (0-127)

This sets the amplitude depth of the speeds of the rotor.

Fader 7—ROT PanDep (0-127)

This controls the amount of left to right panning.

Fader 8—ROT FM Dep (0-127)

This controls the frequency modulation as determined by the speeds. Use this to create a “Doppler” effect.

Fader 9—DRM Hi (0-127)

This sets the maximum drum speed.

Fader 10—DRM Acc (0-127)

This sets the amount of time it takes for the drum to go from low to high speed.

Fader 11—DRM Lo (0-127)

This sets the minimum drum speed.

Fader 12 DRM Decel (0-127)

This sets the amount of time it takes for the drum to go from high to low speed.

Fader 13—DRM Vol (0-127)

This sets the volume of the drum.

Fader 14—DRM Am Depth (0-127)

This sets the amplitude depth of the drum.

Fader 15—DRM PanDepth (0-127)

This controls the amount of left to right panning.

Fader 16—WET Level (0-127)

This sets the wet/dry mix.

Button 1—R. Spkr Speed

This sets the rotor and drum to either low or high speed. (MIDI controller not saved in preset.)

Organ Drv/Spkr

Fader 1—DIST CTRL (0-127)

This sets the level of the distortion mix. (MIDI controller not saved in preset.)

Fader 2—Dist Type0-4 (0-4)

This selects the amount of distortion to use. A setting of 0 turns the distortion off, while 1 through 4 offer increasing amounts of distortion.

Fader 3—Dist Amount (0-127)

This fine tunes the distortion amount selected.

Fader 4—Dist Drylev (0-127)

This sets the amount of straight signal that passes through.

Fader 5—Dist Wetlev (0-127)

This sets the amount of effected signal that passes through.

Faders 6-8

These faders are undefined.

Fader 9—SSIM LP Fr (0-127)

This sets the upper limit of the frequency of the filter. This is a special filter for emulating speaker enclosures.

Fader 10—SSIM LP Q (0-127)

This sets the resonant frequency of the filter.

Fader 11—SSIM DRY (0-127)

This sets the amount of straight signal that passes through.

Fader 12—SSIM WET (0-127)

This sets the amount of effected signal that passes through.

Organ Vib/Rev

Fader 1—VIB Rate (0-127)

This sets the speed of the vibrato.

Fader 2—VIB Depth (0-127)

This sets the depth of the vibrato.

Fader 3—VIB Delay (0-127)

This sets the amount of delay before the vibrato starts.

Fader 4—VIB Fdbk (0-127)

This determines how much of the signal get re-effected.

Fader 5—VIB Mix (0-127)

This sets the wet/dry level. Set to 127 for vibrato, or lower (near 64) for chorus.

Faders 6-8

These faders are undefined.

Fader 9—Reverb Time (0-127)

This sets the size of the room.

Fader 10—Reverb Damp (0-6)

This sets the amount of the high frequency to be reduced. (0=full frequency response.)

Fader 11—Reverb Dry (0-127)

This sets the amount of straight signal that is passed through.

Fader 12—Reverb Wet (0-127)

This sets the amount of effected signal that is passed through.

WAVEFORM REFERENCE LIST

B3

Wave Number	Wave Type
0	sine
1	single drawbar
2	888888888
3	888800000
4	888400000
5	888000000
6	880000000
7	808800000
8	808000000
9	800800000
10	pedal88
11	pedal86
12	percussion

VOX

Wave Number	Wave Type
13	vox1
14	vox2
15	vox3
16	vox4
17	vox5
18	vox6
19	vox7
20	vox8

Farfisa

Wave Number	Wave Type
21	farfisa1
22	farfisa2
23	farfisa3
24	farfisa4
25	farfisa5
26	farfisa6
27	farfisa7
28	farfisa8
29	farfisa9
30	farfisa10
31	farfisa11

CX-3

Wave Number	Wave Type
32	cx3-1
33	cx3-2
34	cx3-3
35	cx3-4
36	cx3-5

Pipes

Wave Number	Wave Type
37	pipe1
38	pipe2
39	pipe3
40	cathedral1
41	cathedral2

Other Organs

Wave Number	Wave Type
42	Metal Organ
43	B3
44	Jazz B3
45	Full B3
46	4' Percussion Loop
47	B3 2ft

Attacks

Wave Number	Wave Type
48	synclk1
49	synclk2
50	synclk3
51	synclk4
52	synclk5
53	synclk6
54	synclk7
55	synclk8
56	synclk9
57	blokhead
58	noiseclk
59	spector
60	thkclk
61	voxclock

Sine Waves

Wave Number	Wave Type
62	sine -3 dB
63	sine -6 dB
64	sine -9 dB
65	sine -12 dB
66	sine -15 dB
67	sine -18 dB

Appendix A Effects/Voice Architectures

Effects Architecture

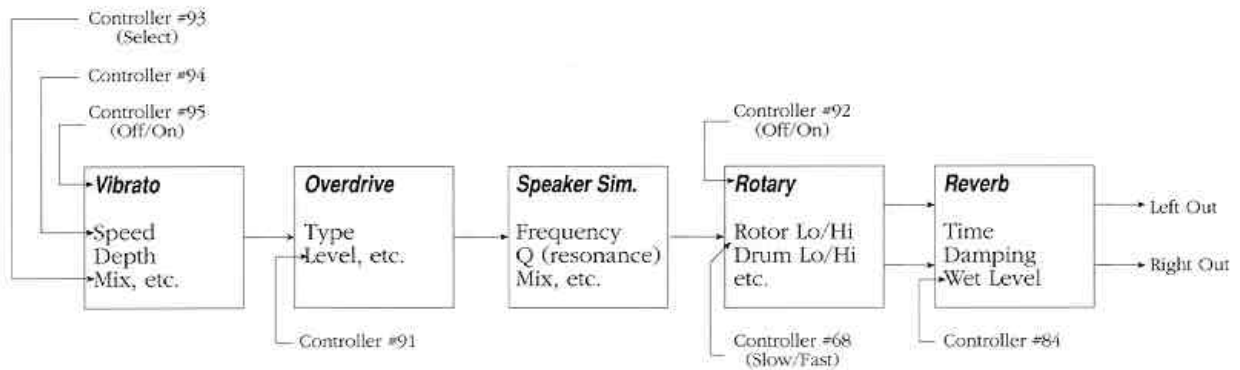

Voice Architecture

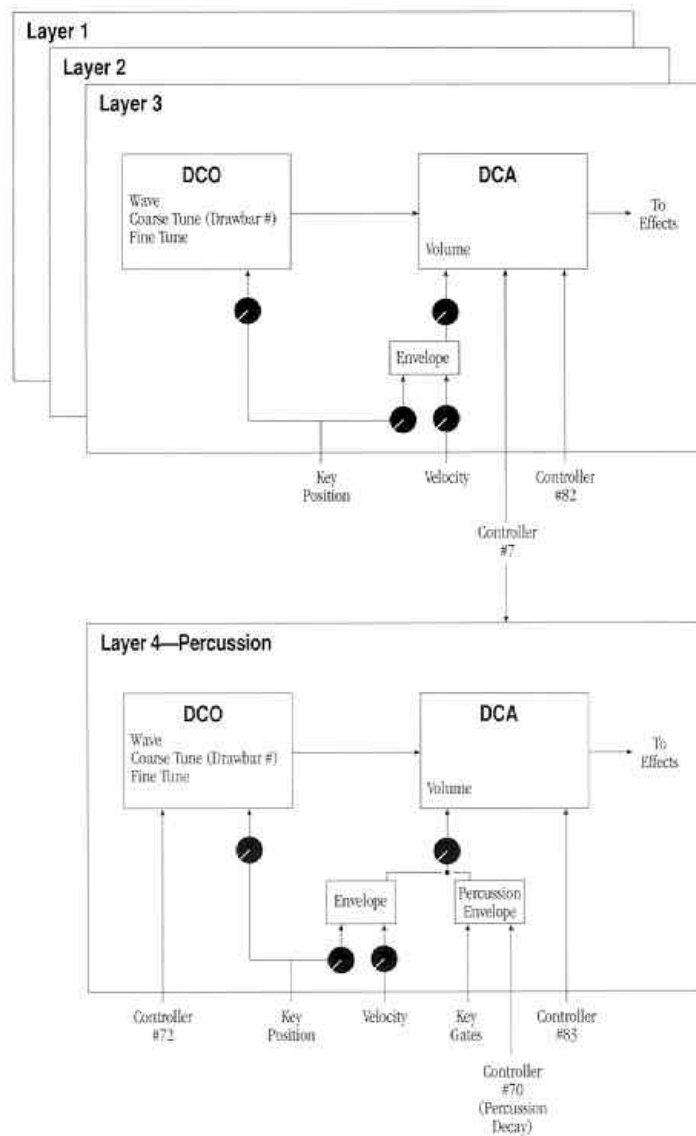

Appendix B MIDI Implementation

MIDI Implementation

Model: Spectrum Organ

Date: 12/94
Version: 1.0

Function		Transmitted*	Recognized	Remarks
Basic Channel	Default Channel	1 1-16	1 1-16	
Mode	Default Messages Altered	X X X	X X X	Set at front panel
Note Number	True Voice	0-127	24-108	
Velocity	Note On Note Off	0 0	0 0	
After-touch	Key's Ch's	X 0	X 0	Maps to any control change
Pitch Bender		0	0	
Control Change		1 - Mod Wheel 7 - Volume 64 - Sustain 68 - Rotary Slow/Fast 70 - Percussion Decay 71 - Percussion Mode 72 - Percussion Pitch 80-83 - Drawbar Volumes 1-4 84 - Reverb Wet Level 91 - Overdrive Level 92 - Rotary Off/On 93 - Vibrato Select 94 - Vibrato Speed 95 - Vibrato Off/On 120 - All Sound Off 121 - Reset All Controllers 123 - All Notes Off	Same	Mod Wheel can be mapped to any control change.
Program Change	True#	0-127	0-127	
System Exclusive		0	0	
System Common	: Songs Pos : Song Sel : Tune	X X X	X X X	
System Real Time	: Clock : Commands	X X	X X	
Auxiliary Messages	: Local On/Off : All Notes Off : Active Sense : Reset	X 0 X X	X 0 X X	
* Transmitted in overflow				

Mode 1 : OMNI ON, POLY Mode 2 : OMNI ON, MONO
Mode 3 : OMNI OFF, POLY Mode 4 : OMNI OFF, MONO

O : Yes
X : No

Appendix C SysEx and Controller Data

SPECTRUM ORGAN SYSTEM EXCLUSIVE IMPLEMENTATION

The Spectrum Organ has a system exclusive (*sysex*) implementation which makes it possible to perform basic parameter editing of the program currently in the edit buffer. The contents of this edit buffer are lost on power down since there is no nonvolatile RAM in the unit. Therefore, the user must save an editing session by executing a sysex dump of the edit buffer contents, saving the parameter data to a MIDI librarian (such as the Peavey MIDI Streamer or a computer software sysex librarian).

Spectrum Organ System Exclusive Command Format (see Table 1)

F0	System Exclusive command
00 00 1B	Peavey vendor I.D.
02	Keyboard family I.D.
0D	Spectrum Organ I.D.
<ch>	MIDI receive channel
<cmd>	System Exclusive command (byte #7 in Table 1)
<data>	command-specific data (<i>n</i> bytes)
F7	End of System Exclusive

Note: All system exclusive bytes are transmitted in hexadecimal (hex) format.

	sysex message byte offset												
	0	1	2	3	4	5	6	7	8	9	10	11	12
Update Global Parameter	F0	00	00	1B	02	0D	channel	00	MS offset	LS offset	MS value	LS value	F7
Update Edit Buffer Parameter								01	MS offset	LS offset	MS value	LS value	F7
Initialize Edit Buffer								02	F7				
Receive Edit Buffer								03	d	a	t	a	...
Dump Edit Buffer								04	F7				

— MS = MS 7-bit byte of 14-bit value
 — LS = LS 7-bit byte of 14-bit value

Table 1: System Exclusive Commands Recognized by Spectrum Organ

Global and edit buffer parameter offsets and values are transmitted via MIDI to the Spectrum Organ by the Peavey PC 1600 (or other sysex editor) in a 14-bit format. These 14 bits, when included as part of a sysex message, are tokenized as 2 bytes in the form *most significant byte* (MSB) followed by *least significant byte* (LSB). Each byte contains the respective 7 bits of the offset or value with the high bit clear (set to "0", see Figure 1).

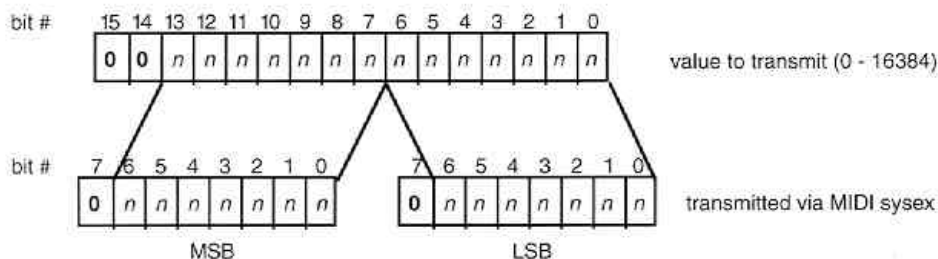

Figure 1: Tokenized System Exclusive byte format

Note: The following examples assume that the Spectrum Organ is set to receive MIDI information on channel 1.

Example 1:

To update the **layer volume** parameter of layer 4 in the edit buffer to reflect the maximum volume (127), the following sysex message would be sent:

F0 00 00 1B 02 0D 00 01 00 43 00 7F F7
 └───┬───┘
 offset value

Example 2:

To initialize the edit buffer of the Spectrum Organ to generic values, the following sysex message would be sent:

F0 00 00 1B 02 0D 00 02 F7

Example 3:

To update the global **key transpose** parameter to reflect a detuning of five (-5) semitones, the following sysex message would be sent:

F0 00 00 1B 02 0D 00 00 00 01 7F 7B F7
 └───┬───┘
 offset value

Note: Negative hex values (i.e., -5) are represented in a 2-byte, 14-bit *two's complement* format (see Figure 1).

Example 4:

To transmit the contents of the edit buffer to MIDI (**Dump Edit Buffer**), the following sysex message would be sent:

F0 00 00 1B 02 0D 00 04 F7

Example 5:

To load the edit buffer with a previously-saved edit buffer dump (**Receive Edit Buffer**), the following sysex message would be sent:

F0 00 00 1B 02 0D 00 03 <parameter data> F7
272 nibblized MIDI bytes

Following are tables enumerating program and global parameter descriptions, offsets, and valid value ranges for the Spectrum Organ.

Parameter Description	Edit Buffer Offset (hex)	Valid Range		Notes
		min	max	
<u>PROGRAM PARAMETERS</u>				
Overall Program Volume	0	0	99	
Percussion Envelope Decay Time	1	0	99	
Remap Mod Wheel to Controller #	2	0	127	
Remapped Mod Wheel Scale	3	0	255	0 - 127: 0 - # mapping 128 - 255: (255 - #) - 127 mapping
Remap Channel & Poly Pressure to Controller #	4	0	127	0=OFF
Remapped Pressure Scale	5	0	128	

Parameter Description	Edit Buffer Offset (hex)	Valid Range		Notes
		min	max	
not used	6	x	x	
not used	7	x	x	
not used	8	x	x	
not used	9	x	x	

ENVELOPE PARAMETERS

Amp level modulation by velocity	A	-99	99	0 = none
Amp level modulation by key position	B	-99	99	0 = none
Amp time modulation by velocity	C	-99	99	0 = none
Amp time modulation by key position	D	-99	99	0 = none
Amp1 level	E	0	99	
Amp2 level	F	0	99	
Amp3 level	10	0	99	
Amp4 level	11	0	99	
Amp1 time (time = 1 / rate)	12	0	99	
Amp2 time	13	0	99	
Amp3 time	14	0	99	
Amp4 time	15	0	99	
not used	16	x	x	
not used	17	x	x	

LAYER (1,2,3,4) PARAMETERS

		(1)	(2)	(3)	(4)		
Layer Enable (see bits below)	bit #	18	26	34	42	0	31
Layer OFF / ON	0					0	1
use as Percussive Layer	1					0	1
Percussion Type	2					0	1
Percussive Click OFF / ON	3					0	1
Key Tune Bias	4					0	1
Layer Volume		19	27	35	43	0	127
Minimum MIDI Note to Recognize		1A	28	36	44	0	127
Maximum MIDI Note to Recognize		1B	29	37	45	0	127
Minimum Velocity to Recognize		1C	2A	38	46	0	127
Maximum Velocity to Recognize		1D	2B	39	47	0	127
Oscillator Wave Shape		1E	2C	3A	48	0	67
Oscillator Tuning - Course		20	2E	3C	4A	-24	24
Oscillator Tuning - Fine		21	2F	3D	4B	-99	99
Oscillator Tuning - Drawbar Selection		22	30	3E	4C	0	9
Pitch Modulation by Key		23	31	3F	4D	-99	99
Layer Start Delay Time		24	32	40	4E	0	99
not used		25	33	41	4F	x	x
not used				50		x	x
not used				51		x	x
not used				52		x	x
not used				53		x	x

0 = OFF
0 = NO, 1 = YES
0 = authentic (B3), 1 = modern
0 = OFF
0 = OFF
WORD storage
semitones, 0=A440 tuning
cents 0 = OFF
0 = ignore
-99 = all keys same

ROTARY PARAMETERS

Rotor High Speed	54	0	127
Rotor Acceleration Rate	55	0	127
Rotor Low Speed	56	0	127
Rotor Deceleration Rate	57	0	127
Rotor Amplitude Modulation Depth	58	0	127
Rotor Pan Modulation Depth	59	0	127
Rotor Frequency Modulation Depth	5A	0	127

Parameter Description	Edit Buffer Offset (hex)	Valid Range		Notes
		min	max	
Rotor Volume Level	5B	0	127	
Drum High Speed	5C	0	127	
Drum Acceleration Rate	5D	0	127	
Drum Low Speed	5E	0	127	
Drum Deceleration Rate	5F	0	127	
Drum Amplitude Modulation Depth	60	0	127	
Drum Pan Modulation Depth	61	0	127	
Drum Volume Level	62	0	127	
Rotary Initial Speed	63	0	2	0=same, 1=fast, 2=slow
Rotary Dry/Wet Mix	64	0	127	
not used	65	x	x	
not used	66	x	x	
not used	67	x	x	
<u>SPEAKER SIMULATOR PARAMETERS</u>				
Low-Pass Filter Corner Frequency	68	0	127	
Low-Pass Filter Q	69	0	127	
Dry Level	6A	0	127	
Wet Level	6B	0	127	
not used	6C	x	x	
not used	6D	x	x	
<u>OVERDRIVE PARAMETERS</u>				
Type	6E	0	4	
Drive	6F	0	127	
Dry Level	70	0	127	
Wet Level	71	0	127	
not used	72	x	x	
not used	73	x	x	
<u>VIBRATO PARAMETERS</u>				
Rate	74	0	127	
Depth	75	0	127	
Delay Time	76	0	127	
Feedback	77	0	127	
Dry/Wet Mix	78	0	127	
not used	79	x	x	
not used	7A	x	x	
<u>REVERB PARAMETERS</u>				
not used	7B	x	x	
not used	7C	x	x	
Time	7D	0	127	
Damping	7E	0	6	0 = full range
Dry Level	7F	0	127	
Wet Level	80	0	127	
not used	81	x	x	
not used	82	x	x	
not used	83	x	x	
not used	84	x	x	
not used	85	x	x	
not used	86	x	x	
not used	87	x	x	

The Spectrum Organ has a small EEPROM memory which is used to store the status of all global parameters and a few standard values. Global parameter values listed in the table below are not lost on power-down and are immediately accessible on power-up. Also stored is the most-recent program configuration: Program number for the basic MIDI channel + program numbers of the multi mode channels if unit is set to one of the possible multi modes (**MIDI Mode** = 2, 3, or 4; see table below).

<u>Parameter Description</u>	<u>Global Offset</u>	<u>Valid Range</u>		<u>Notes</u>
		<u>min</u>	<u>max</u>	
<u>GLOBAL PARAMETERS</u>				
Fine Tuning	0	-99	99	cents 0 = OFF
Key Transpose	1	-24	24	semitones 0 = A440 tuning
Rotary Setting	2	0	11	see "Effects Table" below
Overdrive	3	0	11	"
Vibrato	4	0	7	see "Vibrato Table" below
Speaker Simulator	5	0	11	see "Effects Table" below
Reverb	6	0	11	"
Release Click	7	0	2	0 = OFF, 1 = program, 2 = ON
MIDI Mode	8	0	4	see "MIDI Mode Table" below
MIDI Channel	9	0	15	MIDI channel - 1

Effects Table

value	setting
0	OFF
1	program
2	global setting #1
3	global setting #2
4	"
5	"
6	"
7	"
8	"
9	"
10	"
11	global setting #10

Vibrato Table

value	effect
0	OFF
1	program
2	Vibrato 1
3	Vibrato 2
4	Vibrato 3
5	Chorus 1
6	Chorus 2
7	Chorus 3

MIDI Mode Table

value	mode
0	omni
1	poly
2	2-channel multi
3	3-channel multi
4	4-channel multi

Universal SysEx Messages

The Spectrum Organ sends the MIDI Master Volume string when the C.V. pedal is used (so an autoflow unit will track) It will also accept this message from any source.

F0 7F <device id> 04 01 lsb msb F7

The Spectrum Organ's device id is 64.

lsb and msb should be a 14-bit value.

Controller Data

Controller Number	Controller Name	Range	Comments
1	Mod Wheel	0-127	
7	Volume	0-127	
64	Sustain	0-127	
68	Rotary Slow/Fast	0-127	
70	Percussion Decay	0-127	
71	Percussion Mode	0-127	
72	Percussion Pitch	0-127	0-14=drawbar #1, -12 semitones 15-29=drawbar #2, -07 semitones 30-44=drawbar #3, +00 semitones 45-59=drawbar #4, +12 semitones 60-74=drawbar #5, +19 semitones 75-89=drawbar #6, +24 semitones 90-104=drawbar #7, +28 semitones 105-119=drawbar #8, +31 semitones 120-127=drawbar #9, +36 semitones
80-83	Drawbar Volumes 1-4	0-127	
84	Reverb Wet Level	0-127	
91	Overdrive Level	0-127	
92	Rotary Off/On	0-127	
93	Vibrato Select	0-127	0-15=OFF 16-31="PRG" 32-47=V1 48-63=V2 64-79=V3 80-95=C1 96-111=C2 112-127=C3
94	Vibrato Speed	0-127	
95	Vibrato Off/On	0-127	
120	All Sound Off	0-127	
121	Reset All Controllers	0-127	
123	All Notes Off	0-127	

Appendix D History of the B3

At the concert, the audience and press were ecstatic. A writer for the popular McClure's Magazine, described the music as "singularly clear, sweet" and surprisingly free of "the whirl of machinery." A writer in Electrical World called the instruments tone "remarkably pure and beautiful."

This event took place March 16, 1907, in the ballroom of the Hotel Hamilton in Holyoke, Massachusetts. The instrument was the Tel Harmonium. Nearly a mile away the gears of the first synthesizer spun. The two hundred ton instrument filled a renovated factory. The current that flowed from the 145 alternators was channeled through a maze of telephone switches and directed via telephone line to the hotel, where it emerged, from a single loudspeaker placed on a chair in the middle of the dance floor.

This concert was the culmination of twenty-two years work with electricity by inventor Thaddeus Cahill. As he wrote in his patent application, the "grand objects" of his Tel Harmonium were to "generate music electrically with tones of good quality and great power and with perfect musical expression."

Later, in 1933, American clock builder Laurens Hammond started looking for a different application for his synchronous motor. Building on Cahill's findings, and the benefit of vacuum tube amplifiers, Hammond built an electric organ. The first prototype was publicly displayed in April, 1935, at the Industrial Arts Exposition in Radio City's RCA building. Hammond's first customer was one Bob Pierce, and his organ now resides in the Smithsonian. Other early customers included Gershwin and Henry Ford.

The Hammond electric organ was a hit but not with the traditional pipe organ community. Also it didn't help matters any that Hammond ads were claiming the organ "covers the entire tone coloring necessary for the rendition, without sacrifice, of the great works of classical organ literature." This only provoked the opposition. In 1936 the Federal Trade Commission prosecuted Hammond for calling his instrument an organ. Finally, in a musical showdown of sorts, the Hammond organ was pitted against a \$75,000 Skinner pipe organ in a blindfold test at the University of Chicago's chapel. Amazingly, very few of the "experts" and students could tell the difference between them. Hammond eventually won the right to call his electric instrument an organ, though the FTC banned Hammond's ambitious advertising. Early model A organs still have "Hammond Clock Company" stamped on them.

The Hammond organ went on to become a standard for many institutions such as radio and television studios, churches, even military base chapels. The reliability and portability made it the perfect choice for missionaries in remote areas like Africa. It was embraced by the professional musician for its pure tones, and its "fast attack" which blended well with the likes of electric guitars and drums.

The original basic design didn't change much over the years but some notable improvements were made. The first model being the A, 1935-1938, used a single tone generator with tremulant effecting both manuals simultaneously. The BC model, 1936-1942, added a second tone generator and appropriate switching to create chorus effect. The C, 1939-1942, was the same as the A, but the church model. The BV and CV, 1945-1949, were equipped with three degrees of true vibrato and vibrato chorus effective simultaneously on both manuals. The B-2 and C-2, 1949-1954, offered vibrato and vibrato chorus which could be applied to either or both manuals independently. The B-3 and C-3, 1955-1975, added percussion to the upper manual.

It's amazing that this organ was manufactured virtually unchanged from it's inception, in 1935 through 1975. The B-3, which by the way is the most famous model, was manufactured for twenty years with no significant changes. No history of the Hammond organ would be complete however without discussing another instrument made by a completely different company.

Enter the Leslie Speaker. The typical Leslie has an upper driver fed into a rotating horn and a lower 15" speaker directed into a rotating drum. These rotating deflectors can change speeds from slow to fast and in some cases stop. Many of you have heard these speakers and what they do to the Hammond organ, but how did they come to be?

Don Leslie was a radio service engineer at Barker Bros. department store in L.A., one of the first Hammond franchises. In 1937 he bought a Hammond organ believing it would sound like a pipe organ. It apparently sounded impressive in the showroom but sounded hopelessly flat at home. To save money he had decided to build his own speaker rather than buy one.

His first design was fashioned after the Hammond speaker and by his estimates, was a failure. He continued to experiment noting that when playing a pipe organ, the sound moves as different pipes speak. He tried many ways to accomplish this motion until the familiar system of fixed speakers with deflectors was born. In 1940 he told Hammond that he had something they should be interested in. They didn't like the idea and brushed him off. It's interesting to note that Hammond and Leslie didn't get along at all. At the music trade shows they would spy on each other. Hammond would design his organ so that only a Hammond speaker would work. A week later Leslie would make an adapter that would make his speaker compatible again. Though the Hammond executives and employees spoke unfavorably about the Leslie speaker, privately many owned Leslie's with their personal organs at home. Leslie sold his first speaker in 1940 and maintained his company until 1965. He then sold Electro Music to CBS. They eventually sold it to Hammond in 1980.

Today, the classic sound of the B3 and Leslie is enjoying a comeback. Many recording studios maintain Hammond's and Leslie's. Many churches still seek the ultimate B-3 or C-3 with a couple of Leslie's. Hundreds of thousands were made and they were made to last so they will be around for a long time to come.

Credits: George Benton, Hammond Expert; Matthew Nicholl, Invention and Technology Magazine, Spring 1993; Mark Vail, Keyboard Magazine, April '90, June '90, September '91; Organ Service Company, Service Literature

THIS LIMITED WARRANTY VALID ONLY WHEN PURCHASED AND REGISTERED IN THE UNITED STATES OR CANADA. ALL EXPORTED PRODUCTS ARE SUBJECT TO WARRANTY AND SERVICES TO BE SPECIFIED AND PROVIDED BY THE AUTHORIZED DISTRIBUTOR FOR EACH COUNTRY.
Ces clauses de garantie ne sont valables qu'aux Etats-Unis et au Canada. Dans tous les autres pays, les clauses de garantie et de maintenance sont fixées par le distributeur national et assurées par lui selon la législation en vigueur.
Diese Garantie ist nur in den USA und Kanada gültig. Alle Export-Produkte sind der Garantie und dem Service des Importeurs des jeweiligen Landes unterworfen. Esta garantía es válida solamente cuando el producto es comprado en E.U. continentales o en Canada. Todos los productos que sean comprados en el extranjero, están sujetos a las garantías y servicio que cada distribuidor autorizado determine y ofrezca en los diferentes países.

**PEAVEY ONE-YEAR LIMITED
WARRANTY/REMEDY**

PEAVEY ELECTRONICS CORPORATION ("PEAVEY") warrants this product, EXCEPT for covers, footswitches, patchcords, tubes and meters, to be free from defects in material and workmanship for a period of one (1) year from date of purchase, PROVIDED, however, that this limited warranty is extended only to the original retail purchaser and is subject to the conditions, exclusions, and limitations hereinafter set forth:

PEAVEY 90-DAY LIMITED WARRANTY ON TUBES AND METERS

If this product contains tubes or meters, Peavey warrants the tubes or meters contained in the product to be free from defects in material and workmanship for a period of ninety (90) days from date of purchase; PROVIDED, however, that this limited warranty is extended only to the original retail purchaser and is also subject to the conditions, exclusions, and limitations hereinafter set forth.

CONDITIONS, EXCLUSIONS, AND LIMITATIONS OF LIMITED WARRANTIES

These limited warranties shall be void and of no effect, if:

- a. The first purchase of the product is for the purpose of resale; or
- b. The original retail purchase is not made from an AUTHORIZED PEAVEY DEALER; or
- c. The product has been damaged by accident or unreasonable use, neglect, improper service or maintenance, or other causes not arising out of defects in material or workmanship; or
- d. The serial number affixed to the product is altered, defaced, or removed.

In the event of a defect in material and/or workmanship covered by this limited warranty, Peavey will:

- a. In the case of tubes or meters, replace the defective component without charge.
- b. In other covered cases (i.e., cases involving anything other than covers, footswitches, patchcords, tubes or meters), repair the defect in material or workmanship or replace the product, at Peavey's option; and provided, however, that, in any case, all costs of shipping, if necessary, are paid by you, the purchaser.

THE WARRANTY REGISTRATION CARD SHOULD BE ACCURATELY COMPLETED AND MAILED TO AND RECEIVED BY PEAVEY WITHIN FOURTEEN (14) DAYS FROM THE DATE OF YOUR PURCHASE.

In order to obtain service under these warranties, you must:

- a. Bring the defective item to any PEAVEY AUTHORIZED DEALER or AUTHORIZED PEAVEY SERVICE CENTER and present therewith the ORIGINAL PROOF OF PURCHASE supplied to you by the AUTHORIZED PEAVEY DEALER in connection with your purchase from him of this product.

If the DEALER or SERVICE CENTER is unable to provide the necessary warranty service you will be directed to the nearest other PEAVEY AUTHORIZED DEALER or AUTHORIZED PEAVEY SERVICE CENTER which can provide such service.

OR

- b. Ship the defective item, prepaid, to:

PEAVEY ELECTRONICS CORPORATION
International Service Center
326 Hwy. 11 & 80 East
MERIDIAN, MS 39301

including therewith a complete, detailed description of the problem, together with a legible copy of the original PROOF OF PURCHASE and a complete return address. Upon Peavey's receipt of these items:

If the defect is remedial under these limited warranties and the other terms and conditions expressed herein have been complied with, Peavey will provide the necessary warranty service to repair or replace the product and will return it, FREIGHT COLLECT, to you, the purchaser.

Peavey's liability to the purchaser for damages from any cause whatsoever and regardless of the form of action, including negligence, is limited to the actual damages up to the greater of \$500.00 or an amount equal to the purchase price of the product that caused the damage or that is the subject of or is directly related to the cause of action. Such purchase price will be that in effect for the specific product when the cause of action arose. This limitation of liability will not apply to claims for personal injury or damage to real property or tangible personal property allegedly caused by Peavey's negligence. Peavey does not assume liability for personal injury or property damage arising out of or caused by a non-Peavey alteration or attachment, nor does Peavey assume any responsibility for damage to interconnected non-Peavey equipment that may result from the normal functioning and maintenance of the Peavey equipment.

UNDER NO CIRCUMSTANCES WILL PEAVEY BE LIABLE FOR ANY LOST PROFITS, LOST SAVINGS, ANY INCIDENTAL DAMAGES, OR ANY CONSEQUENTIAL DAMAGES ARISING OUT OF THE USE OR INABILITY TO USE THE PRODUCT, EVEN IF PEAVEY HAS BEEN ADVISED OF THE POSSIBILITY OF SUCH DAMAGES.

THESE LIMITED WARRANTIES ARE IN LIEU OF ANY AND ALL WARRANTIES, EXPRESSED OR IMPLIED, INCLUDING, BUT NOT LIMITED TO, THE IMPLIED WARRANTIES OF MERCHANTABILITY AND FITNESS FOR A PARTICULAR USE; PROVIDED, HOWEVER, THAT IF THE OTHER TERMS AND CONDITIONS NECESSARY TO THE EXISTENCE OF THE EXPRESSED, LIMITED WARRANTIES, AS HEREINABOVE STATED, HAVE BEEN COMPLIED WITH, IMPLIED WARRANTIES ARE NOT DISCLAIMED DURING THE APPLICABLE ONE-YEAR OR NINETY-DAY PERIOD FROM DATE OF PURCHASE OF THIS PRODUCT.

SOME STATES DO NOT ALLOW LIMITATION ON HOW LONG AN IMPLIED WARRANTY LASTS, OR THE EXCLUSION OR LIMITATION OF INCIDENTAL OR CONSEQUENTIAL DAMAGES, SO THE ABOVE LIMITATIONS OR EXCLUSIONS MAY NOT APPLY TO YOU. THESE LIMITED WARRANTIES GIVE YOU SPECIFIC LEGAL RIGHTS, AND YOU MAY ALSO HAVE OTHER RIGHTS WHICH MAY VARY FROM STATE TO STATE.

THESE LIMITED WARRANTIES ARE THE ONLY EXPRESSED WARRANTIES ON THIS PRODUCT, AND NO OTHER STATEMENT, REPRESENTATION, WARRANTY, OR AGREEMENT BY ANY PERSON SHALL BE VALID OR BINDING UPON PEAVEY.

In the event of any modification or disclaimer of expressed or implied warranties, or any limitation of remedies, contained herein conflicts with applicable law, then such modification, disclaimer or limitation, as the case may be, shall be deemed to be modified to the extent necessary to comply with such law.

Your remedies for breach of these warranties are limited to those remedies provided herein and Peavey Electronics Corporation gives this limited warranty only with respect to equipment purchased in the United States of America.

INSTRUCTIONS — WARRANTY REGISTRATION CARD

1. Mail the completed WARRANTY REGISTRATION CARD to:

PEAVEY ELECTRONICS CORPORATION
POST OFFICE BOX 2898
MERIDIAN, MISSISSIPPI 39302-2898

- a. Keep the PROOF OF PURCHASE. In the event warranty service is required during the warranty period, you will need this document. There will be no identification card issued by Peavey Electronics Corporation.
2. IMPORTANCE OF WARRANTY REGISTRATION CARDS AND NOTIFICATION OF CHANGES OF ADDRESSES:
 - a. Completion and mailing of WARRANTY REGISTRATION CARDS — Should notification become necessary for any condition that may require correction, the REGISTRATION CARD will help ensure that you are contacted and properly notified.
 - b. Notice of address changes — If you move from the address shown on the WARRANTY REGISTRATION CARD, you should notify Peavey of the change of address so as to facilitate your receipt of any bulletins or other forms of notification which may become necessary in connection with any condition that may require dissemination of information or correction.
3. You may contact Peavey directly by telephoning (601) 483-5365.

IMPORTANT SAFETY INSTRUCTIONS

WARNING: When using electric products, basic cautions should always be followed, including the following.

1. Read all safety and operating instructions before using this product.
2. All safety and operating instructions should be retained for future reference.
3. Obey all cautions in the operating instructions and on the back of the unit.
4. All operating instructions should be followed.
5. This product should not be used near water, i.e., a bathtub, sink, swimming pool, wet basement, etc.
6. This product should be located so that its position does not interfere with its proper ventilation. It should not be placed flat against a wall or placed in a built-in enclosure that will impede the flow of cooling air.
7. This product should not be placed near a source of heat such as a stove, radiator, or another heat producing amplifier.
8. Connect only to a power supply of the type marked on the unit adjacent to the power supply cord.
9. Never break off the ground pin on the power supply cord. For more information on grounding, write for our free booklet "Shock Hazard and Grounding."
10. Power supply cords should always be handled carefully. Never walk or place equipment on power supply cords. Periodically check cords for cuts or signs of stress, especially at the plug and the point where the cord exits the unit.
11. The power supply cord should be unplugged when the unit is to be unused for long periods of time.
12. If this product is to be mounted in an equipment rack, rear support should be provided.
13. Metal parts can be cleaned with a damp rag. The vinyl covering used on some units can be cleaned with a damp rag or an ammonia-based household cleaner if necessary. Disconnect unit from power supply before cleaning.
14. Care should be taken so that objects do not fall and liquids are not spilled into the unit through the ventilation holes or any other openings.
15. This unit should be checked by a qualified service technician if:
 - a. The power supply cord or plug has been damaged.
 - b. Anything has fallen or been spilled into the unit.
 - c. The unit does not operate correctly.
 - d. The unit has been dropped or the enclosure damaged.
16. The user should not attempt to service this equipment. All service work should be done by a qualified service technician.
17. This product should be used only with a cart or stand that is recommended by Peavey Electronics.
18. Exposure to extremely high noise levels may cause a permanent hearing loss. Individuals vary considerably in susceptibility to noise induced hearing loss, but nearly everyone will lose some hearing if exposed to sufficiently intense noise for a sufficient time. The U.S. Government's Occupational Safety and Health Administration (OSHA) has specified the following permissible noise level exposures.

Duration Per Day In Hours	Sound Level dBA, Slow Response
8	90
6	92
4	95
3	97
2	100
1 1/2	102
1	105
1/2	110
1/4 or less	115

According to OSHA, any exposure in excess of the above permissible limits could result in some hearing loss. Ear plugs or protectors in the ear canals or over the ears must be worn when operating this amplification system in order to prevent a permanent hearing loss if exposure is in excess of the limits as set forth above. To ensure against potentially dangerous exposure to high sound pressure levels, it is recommended that all persons exposed to equipment capable of producing high sound pressure levels such as this amplification system be protected by hearing protectors while this unit is in operation.

SAVE THESE INSTRUCTIONS!

PEAVEY®

Features and specifications subject to change without notice.

Peavey Electronics Corporation 711 A Street / Meridian, MS 39301 / U.S.A. / (601) 483-5365 / Telex 504115 / Fax 486-1278